

IN PURSUIT OF GROWTH & EXCELLENCE



SDH Series



Contents

Features	01
Software	04
Product Line Up	06
Servo Motor Specifications	08
Servo Drive Specifications	10
Connections With Peripheral Equipment	11
Servo Motor Dimensions	12
Servo Drive Dimensions	14
Wiring Diagram	16
Optional Accessories	20
Motor Shaft Dimensions	21
Electromagnetic Brake Specifications	21

Features

Real time auto tuning, user friendly.

Quick and accurate automatic load inertia ratio estimating function

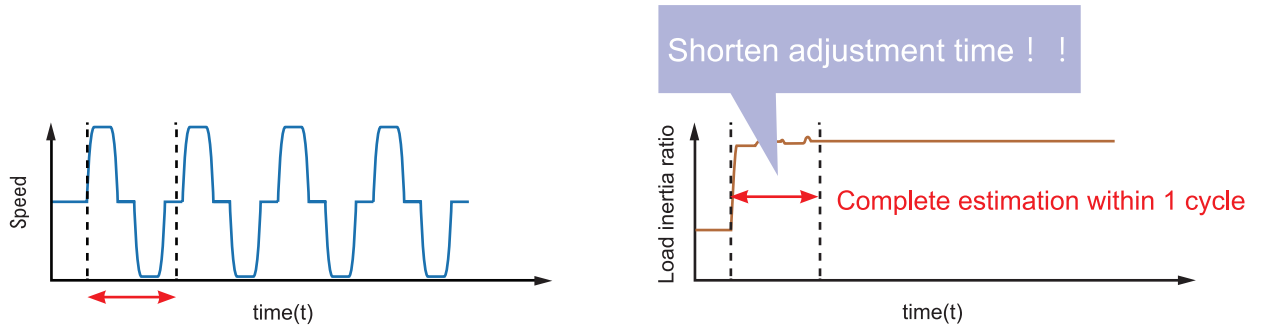

Auto tuning can estimate the load inertia ratio accurately and is suitable for low rigidity to high rigidity application. Either ball screw or belt system can reach excellent positioning performance by auto tuning which could estimate the load inertia ratio within one cycle (forward + reverse) and significantly shorten the adjustment time significantly.

Outstanding speed response performance, 4 times faster



Speed frequency response
1.6k Hz
 ↑
 400 Hz

One of the important characteristics to choose the servo system. The servo speed frequency response is 1.6k Hz, which is faster than the SDB Series 4 times and help to shorten the setting time, improve equipment performance effectively and is the highest frequency response in the MIT Products.

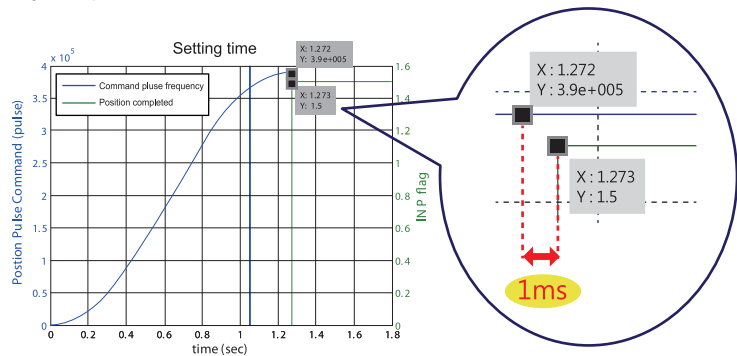

High-resolution



High-resolution encoder
22 Bit
 4,194,304 pulse/rev

Equipped with Japanese high-level absolute position encoder that resolution is up to 4,194,304 pulse / rev could position accurately. The resolution is higher than SDB series 400 times and the speed calculation is faster. Reduce torque ripple during conduction, the motor at low speed is still stable.

Features

Reduce Resonance & Vibration

To inertia system of mechanical, both two low-frequency vibration from the end of arm to main body could be suppressed at the same time by vibration control algorithms. Machine performance is utilized to the fullest using the advanced vibration suppression control function.

Automatic high-frequency vibration suppression function could be turned on directly in motion mode and search for the vibration frequency that through machine resonance suppression filter be controlled. Shorten the setting time and improve equipment performance.



Compatible With Fully Closed Loop Control Optional

Equipped with the secondary encoder port which receives the ABZ pulse signals of mechanism can do precision position control that could reduce the backlash of the transmission mechanism and flexible and ensure the end position accuracy.

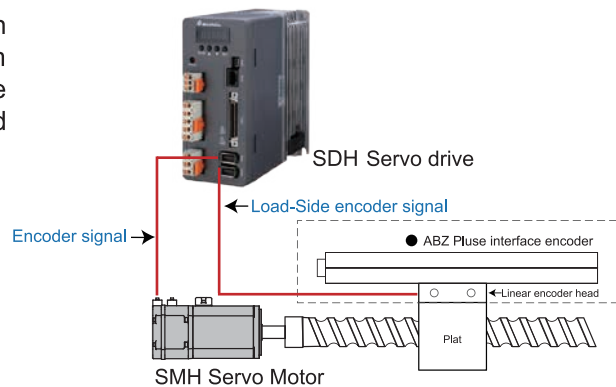

Dual Driver Synchronous System Optional

SDH has new function of gantry dual-driver system which could exchange dual axis location information through simple wiring to upgrade mutual performance and improve positioning accuracy.

At Gantry (dual axis) applications, either the rigid structure or general structure could control both two axes accuracy correctly no matter each load of two axes is the same or not.

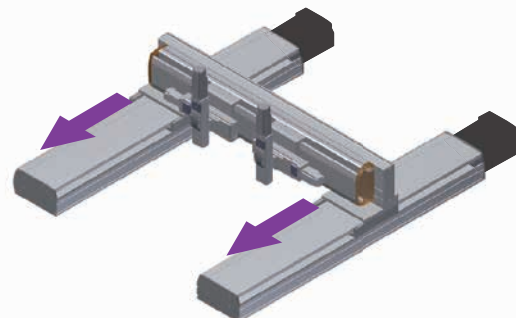

Optional



Absolute Position System

Absolute position



The battery is required when the servo system is in an absolute mode. **The only one of Taiwan-made products whom could exchange absolute position information data with Mitsubishi PLC.**

(Absolute motor and battery is optional)

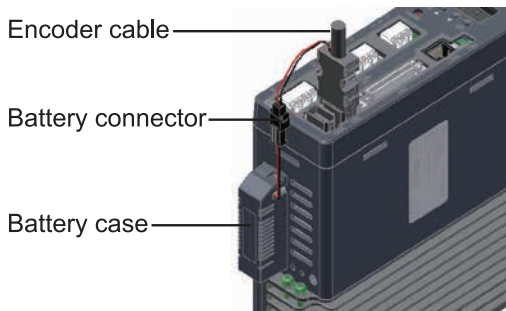

Battery wiring figure

Compact Size

Compact



20% smaller than SMA Series (Example 200W)



SDH Series(New) SMA Series(Existing mode)



Dimension 20% off

Built-in simple PLC function (Single-axis control mode)

With high flexibility and simple position PLC program, help maker to reduce equipment costs.

Multiple control functions

- Program Jump
- Parameter Writing
- Speed Control
- Position Control
- Index Position

Low Level servo driver



SDH Servo drive

Position function High Level PLC

Original cost

Past

Cost down

Built-in PLC position function

Simple PLC

Cost new

New

<Index Position Function>

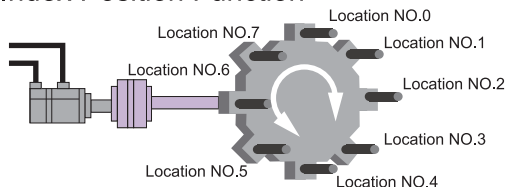

64 Section program

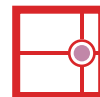

Position edit mode



± limit setup



35 Types home position return mode



Absolute position mode

Function Add

Highly potent servo software

Fully support from setup to troubleshooting

SDH-Soft(Setup software) has the parameter management monitoring function and troubleshooting function which could shorten the setup time.

- Complete control
- Data tracking
- Multiple function monitoring



AC SERVO SYSTEM
SDH Series

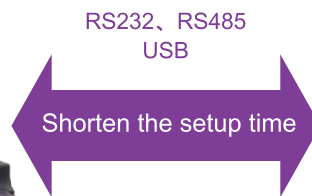

Support Software

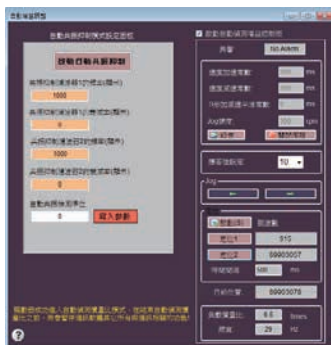

Easy Tuning

Auto gain tuning and inertia estimation interface.

參數	名稱	說明	設定值	初始值	單位	範圍
PA.01	STY	控制模式設定	0001000	0001000	無	0-1159
PA.02	ATUM	自動調諧模式設定	0000002	0000002	無	0-29
PA.03	ATUL	自動調諧速度設定	10	10	無	1-32
PA.04	HECOV	速度控制模式	0000000	0000000	無	0-129
PA.05	TLT	速度控制限制	100	100	%	0-100
PA.06	CDX	電子齒輪分子	1	1	無	1.0-100000
PA.07	CDV	電子齒輪分母	1	1	無	1.0-100000
PA.08	HSPD1	第一段速度限制速度設定	100	100	rpm	1-2000
PA.09	HSPD2	第二段速度限制速度設定	200	200	rpm	1-2000
PA.10	RES1	第一段速度限制	1000	1000	rpm	10-4000

Parameter Management Table

Parameter data reading and writing, File reading and saving, Output printing.

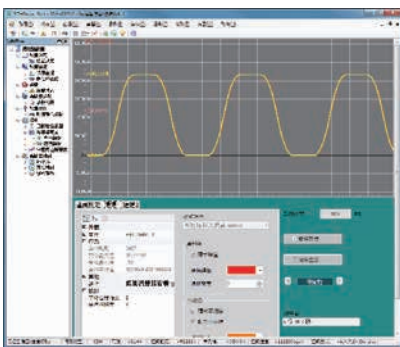

Oscilloscope Function

Oscilloscope long term status capturing function.

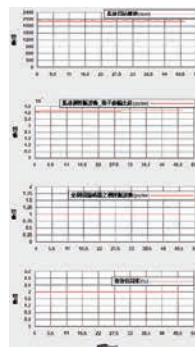

Detail Display

Display various detail reports at the same time and capable of saving those data.



I/O Monitoring

Realize the I/O status on time with I/O monitor display to check if the driver operate normally or not.



Driver Alarm Monitoring

Swiftly and accurately identify the cause and remedy it when alarms occur.

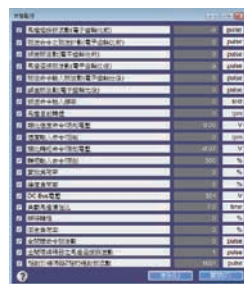

Status Monitoring

Display the servo motor current status on time.(ex.load inertia ratio.,etc.)

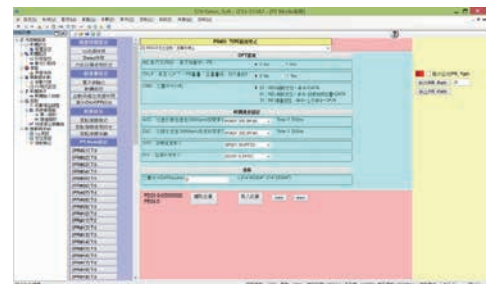

PR Mode Edit

Provide exclusive PR Mode Edit page which could help you complete PLC program quickly.

Product Corresponding Table

Servo Motors	Appearance					
	Capacity	100W	200W	400W	750W	500W
	Standard type	SMH-L010R30S□□	SMH-L020R30S□□	SMH-L040R30S□□	SMH-L075R30S□□	SMH-M050R20S□□
	Absolute position type	SMH-L010R30M□□	SMH-L020R30M□□	SMH-L040R30M□□	SMH-L075R30M□□	SMH-M050R20M□□
Servo Drives	Appearance					
	Capacity	100W	200W	400W	750W	500W
	General type	SDH-010A2A	SDH-020A2A	SDH-040A2A	SDH-075A2A	SDH-050A2A
	Fully closed loop type	SDH-010A2C	SDH-020A2C	SDH-040A2C	SDH-075A2C	SDH-050A2C

Servo Motors Model Definition

SMH - L 010 R30 S A K

Series	Inertia	Motor Capacity	Motor Rated Rotation	Encoder Resolution	Keyway	Motor Type
L	Low Inertia	010 100W	R20 2000RPM	S Standard type(22bit)	NA NO	A NO
M	Medium Inertia	020 200W	R30 3000RPM	M Absolute position type(22bit)	K keyway	B With brake but no oil seal
		040 400W				C No brake, with oil seal
		050 500W				D With brake and oil seal
		075 750W				
		100 1kW				
		150 1.5kW				
		200 2kW				
		350 3.5kW				
		500 5kW				
		700 7kW				

SDH

Series

					
1kW	1.5kW	2kW	3.5kW	5kW	7kW
SMH-M100R20S□□	SMH-M150R20S□□	SMH-M200R20S□□	SMH-M350R20S□□	SMH-M500R20S□□	SMH-M700R20S□□
SMH-M100R20M□□	SMH-M150R20M□□	SMH-M200R20M□□	SMH-M350R20M□□	SMH-M500R20M□□	SMH-M700R20M□□

					
1kW	1.5kW	2kW	3.5kW	5kW	7kW
SDH-100A2A	SDH-150A2A	SDH-200A2A	SDH-350A2A	SDH-500A2A	SDH-700A2A
SDH-100A2C	SDH-150A2C	SDH-200A2C	SDH-350A2C	SDH-500A2C	SDH-700A2C

Servo Drives Model Definition

SDH - 010 A2 A

Series

Motor Capacity	
010	100W
020	200W
040	400W
050	500W
075	750W
100	1kW
150	1.5kW
200	2kW
350	3.5kW
500	5kW
700	7kW

Input Voltage	
A2	200V

Types	
A	General type
C	Fully closed loop type

Servo Motor Specifications

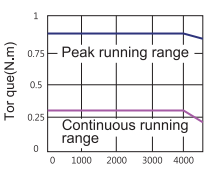
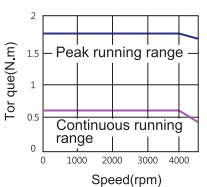
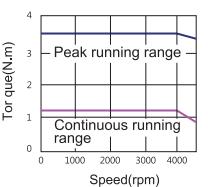
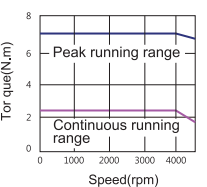
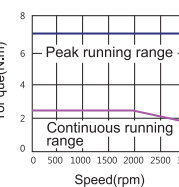
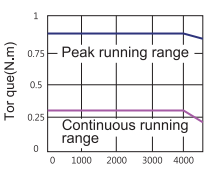
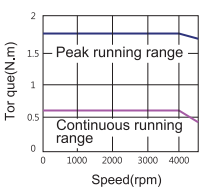
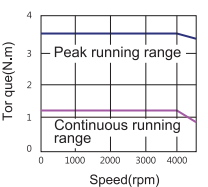
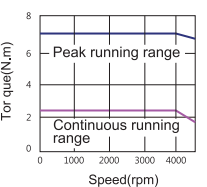
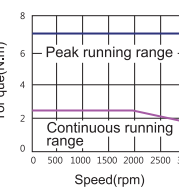
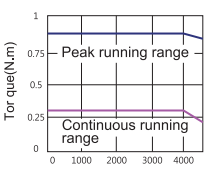
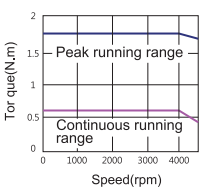
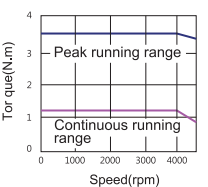
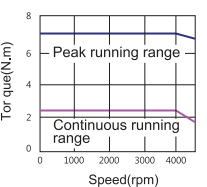
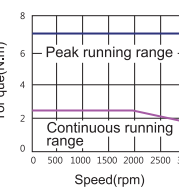
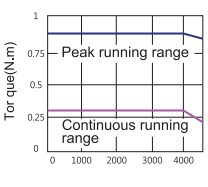
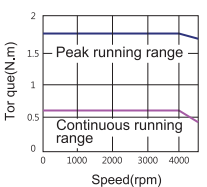
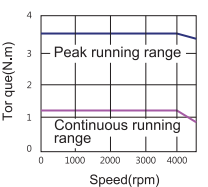
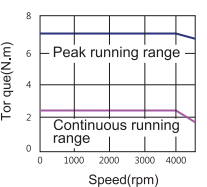
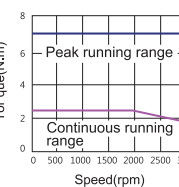
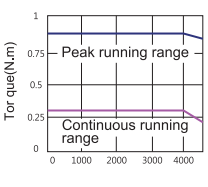
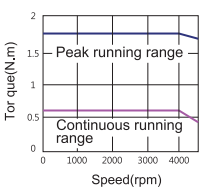
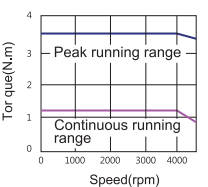
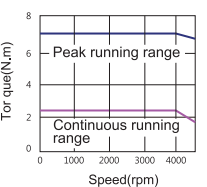
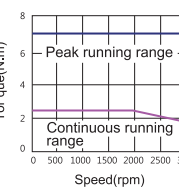
Servo Motors Series		SMH-L□□□R30				
		010	020	040	075	050
Power facility capacity	(kVA)	0.3	0.5	0.9	1.3	1.0
Rated output	(W)	100	200	400	750	500
Rated torque	(N·m)	0.32	0.64	1.27	2.4	2.39
Maximum torque	(N·m)	0.96	1.92	3.81	7.2	7.16
Rated speed	(r/min)	3000				
Maximum speed	(r/min)	4500				
Permissible instantaneous speed	(r/min)	5175				
Rated power ratio	(kW/s)	18.62	19.98	48.29	51.47	8.6
Rated current	(A)	1.0	1.4	2.45	5.0	3.1
Maximum current	(A)	3.0	4.2	7.35	15.0	9.3
Moment of Inertia with brake	J(x10 ⁻⁴ kg·m ²)	0.055/0.058	0.205/0.224	0.334/0.354	1.199/1.244	6.59/8.55
Torque constant	KT(N·m/A)	0.32	0.46	0.52	0.48	0.91
Voltage constant	KE(V/Kmin ⁻¹)	41.0	54.5	59.8	56.0	95.3
Winding resistance	Ra(Ohm)	42.00	11.70	5.63	1.35	3.77
Winding inductance	La(mH)	44.25	42.10	22.95	9.83	19.2
Mechanical time constant	(ms)	1.84	1.01	0.64	0.59	2.99
Electrical time constant	(ms)	1.05	3.51	4.08	7.28	5.09
Insulation class						
Insulation resistance						
Insulation voltage						
Speed and Position Detector						
Environment	Enclosure (IP class)*					
	Working temperature					
	Storage humidity					
	Storage temperature					
	Storage humidity					
	Vibration class					
	Vibration Resistance	x, y : 49 m/s ²				
	Altitude					
Weight	(kg)	0.36 (0.56)	0.83 (1.26)	1.28 (1.71)	2.70 (3.44)	4.6 (6.4)
Safety Certification						
Torque characteristic	Torque VS Speed					
	Torque VS Speed					
	Torque VS Speed					
	Torque VS Speed					
	Torque VS Speed					

SMH-M□□□R20

	100	150	200	350	500	700
	1.7	2.5	3.5	5.5	7.5	10
	1000	1500	2000	3500	5000	7000
	4.78	7.16	9.55	16.7	23.9	33.4
	14.4	21.6	28.5	50.1	71.7	100.2
	2000					
	3000		2500		2000	
	3450		2850		2300	
	18.2	27.7	23.5	37.3	68	92
	5.8	8.5	10	16	20	28
	16.8	25.5	30	48	60	84
	12.56/14.54	18.52/20.61	38.8/49.2	74.8/85.2	84.6/95	121.6/132
	0.94	0.95	1.14	1.18	1.13	1.22
	98.5	99.3	119.5	123.2	135.9	133.3
	1.48	0.89	0.76	0.31	0.25	0.16
	9.12	5.79	8.17	3.99	2.96	2.90
	2.09	1.82	2.26	1.69	1.46	1.25
	6.18	6.54	10.75	12.79	11.72	18.26

F

100MΩ,DC500V

AC1500V,60Hz,60sec

22bit (Absolute position is optional)

IP65 (The shaft-through portion is excluded)

0°C~40°C

Under 80%RH(non freezing)

-15°C~70°C

Under 90%RH(non freezing)

V-15

x, y : 24.5 m/s²

1000m

	6.7 (8.5)	8.8 (10.6)	11.4 (16.7)	17.5 (22.8)	19.1 (24.4)	24.5 (29.8)
--	--------------	---------------	----------------	----------------	----------------	----------------

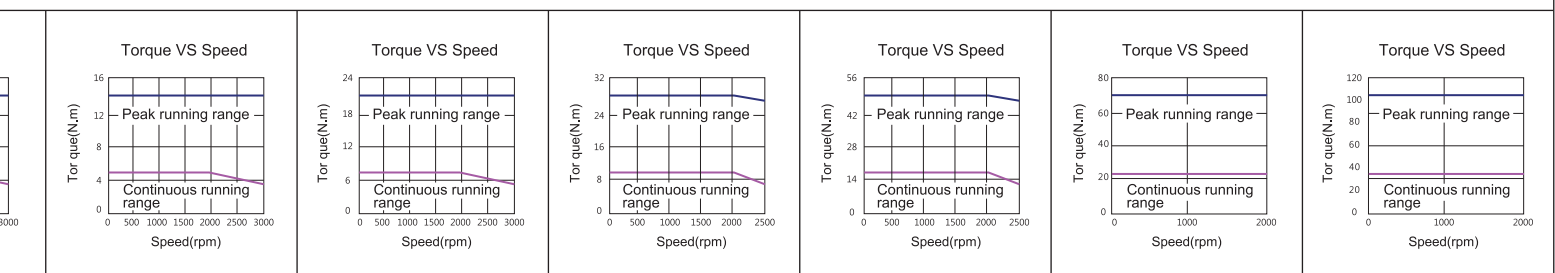

Servo Drive Specifications

Servo Drives Model SDH-□□□A2		010	020	040	050	075	100	150	200	350	500	700
Recommend Servo Motors Model SMH-□□□□		L010	L020	L040	M050	L075	M100	M150	M200	M350	M500	M700
Motor Power		100W	200W	400W	500W	750W	1KW	1.5KW	2KW	3.5KW	5KW	7KW
Main Circuit Power	Voltage / Frequency	3-phase 200~230VAC 50/60Hz or 1-phase 230VAC 50/60Hz					3-phase 200~230VAC 50/60Hz					
	Permissible Voltage Fluctuation	3-phase 170~230VAC 50/60Hz or 1-phase 207~253VAC 50/60Hz					3-phase 170~253VAC 50/60Hz					
	Permissible Frequency Fluctuation	Maximum + 5%										
Control Circuit Power	Voltage / Frequency	1-phase 200~230VAC 50/60Hz										
	Permissible Voltage Fluctuation	1-phase 170~253VAC 50/60Hz										
	Permissible Frequency Fluctuation	Maximum + 5%										
	Power Consumption(W)	30										
Control Method		3-phase full wave rectify, IGBT-PWM controlled (SVPWM drive)										
Dynamic Brake		Built-in										
Protective Functions		Overcurrent, regenerative overvoltage, overload protection, fan failure protection, output short circuit protection, encoder error protection, abnormal regeneration protection, low voltage / instantaneous power failure protection, overspeed protection, excessive error protection										
Encoder Feedback		Standardtype/Absolutetype : 22 bit (4194304 p/rev)										
Communication Interface		RS232/RS485(MODBUS)、USB										
Position Control Mode	Maximum Output Pulse Frequency	500kpps Low Speed / 4Mpps High speed (Line Driver),200kpps (Open Collector)										
	Pulse Command	CCW Pulse train +CW Pulse train : Pulse train + Symbols : A-, B-phase pulse train										
	Command Type	External pulse control / Internal register setup										
	Command Smoothing	Low-pass filter / Linear / S curve										
	Command Pulse Multiplying factor	Electronic gear A/B ratio A : $1 \sim 2^{26}$, B : $1 \sim 2^{26}$, $1/50 < A/B < 64000$										
	Error Excessive	± 3 rotations										
	Torque Limit	Internal parameter setup or external analog Input setup (0~+10VDC/Maximum torque)										
	Feedforward Compensation	Internal parameter setup 0~200%										
Speed Control Mode	Speed Control Range	Analogue speed command 1:2000; Internal speed command 1:5000										
	Command Type	External analog voltage input / Internal register setup										
	Command Smoothing	Low-pass filter / Linear acceleration and deceleration curve / S curve										
	Analog Speed Command Input	0~±10VDC/Rated speed (input impedance: 10~12kΩ)										
	Speed Fluctuation Rate	Load fluctuation 0~100%: $\pm 10\%$ (maximum); power fluctuation $\pm 10\%$: $\pm 0.5\%$ (maximum); Ambient temperature 0°C~55°C: $\pm 0.5\%$ (maximum) (Analog speed command)										
	Torque Limit	Internal parameter setup or external analog Input setup (0~+10VDC/Maximum torque)										
	Bandwidth	Maximum 1.6kHz										
Torque Limitation Mode	Command Type	External analog voltage input										
	Command Smoothing	Low-pass filter										
	Analog Torque Command Input	0~±10VDC/Maximum torque (input impedance: 10~12kΩ)										
	Speed Limit	Internal parameter setup or external analog Input setup (0~+10VDC/Maximum speed)										
Input and Output Signals	Digital Input	Servo on, forward and backward inhibit limits, pulse error clear, torque directionselection, speed command selection, positioning command selection, forward andbackward rotation direction selection, proportion control switching, torque limit switching, abnormal alarm reset, emergency stop, control mode switching, electric gear ratio selection, gain switching										
	Digital Output	Torque limit reached, speed limit reached, servo ready, zero speed reached, position reached, speed reached, alarm signal, Homing completed										
	Analog Input	Analog speed command / limit, analog torque command / limit										
	Analog Output	Command pulse frequency, pulse error, current command, DC bus voltage, serve motor speed, torque value										
Cooling Method		Natural cooling, open (IP20)					Fan cooling, open (IP20)					
Environment	Temperature	0°C~55°C (Force air circulation in the surrounding area if the temperature goes beyond45°C);Storage: -20~65°C (non freezing)										
	Humidity	Maximum 90% RH (non condensing); Storage: Below 90% RH (non condensing)										
	Installation Location	Indoor (avoid direct sun light); no corrosive gas, no flammable gas, no oil mist or dust										
	Altitude	Between sea level and 1000 m										
	Vibration	Maximum 5.9m/s ²										
Weight(kg)		1.4	1.4	1.4	1.4	1.7	1.7	2.6	2.6	2.6	5.9	5.9

Connections With Peripheral Equipment

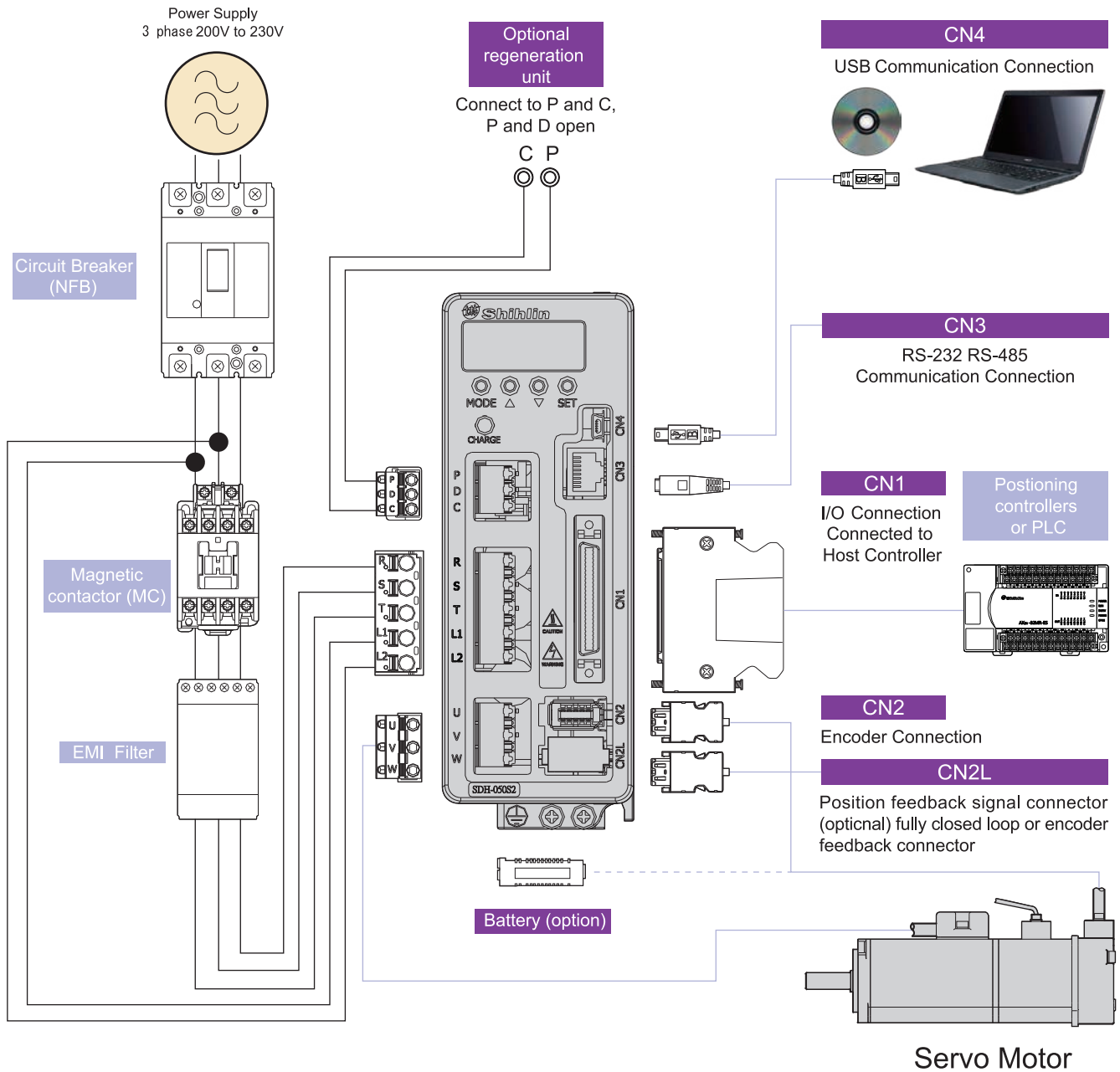

Notes

1. Connect external regeneration unit, please remove P and D short circuit line and connect external resistor to P、C point. Every capacity has its related resistor value, please refer to "Servo Motor Specification" table in this catalog.
2. The general type SDH servo drive has no CN2L connector.
3. With brake type servo motor, the exclusive power cable for must be prepared and need to input DC24V power. Please don't use drive internal VDD connector for power. Please refer to "SDH series User's Manual" for details.
4. The usage of absolute position, please select the optional battery "SDH-BAT-SET" and exclusive encoder cable. Please refer to "SDH series User's Manual" for details.

Servo Motor Dimensions

Unit : mm

Model	L
SMH-L010(B)	88(122.3)

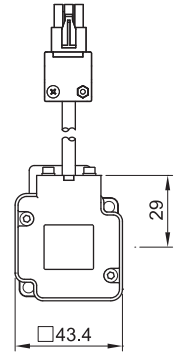
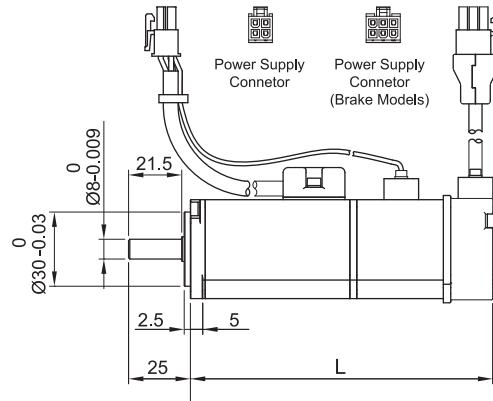
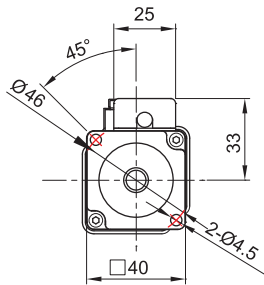

Model	L
SMH-L020(B)	84.1(118.1)
SMH-L040(B)	109.6(143.6)

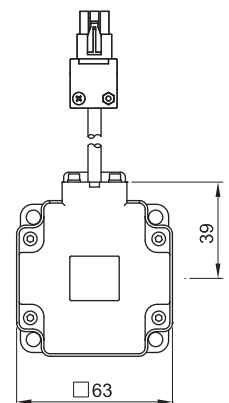
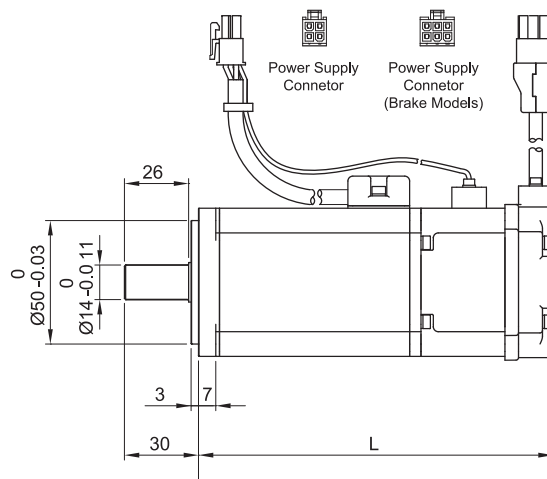
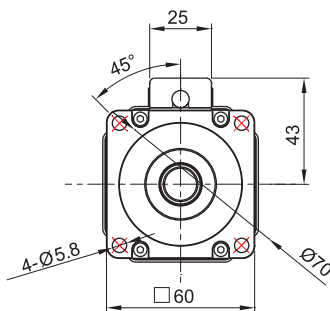

Model	L
SMH-L075(B)	127.5(163.5)

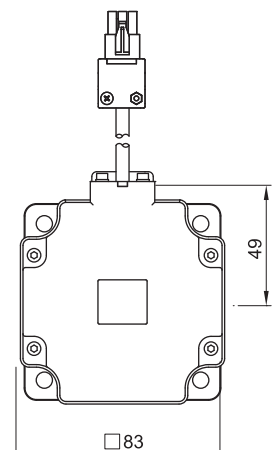
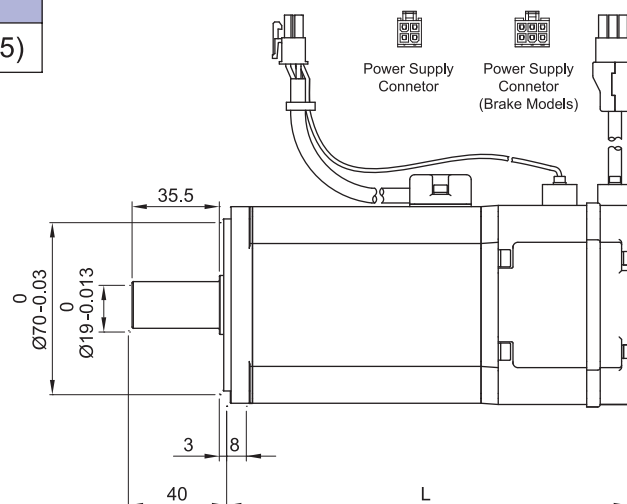
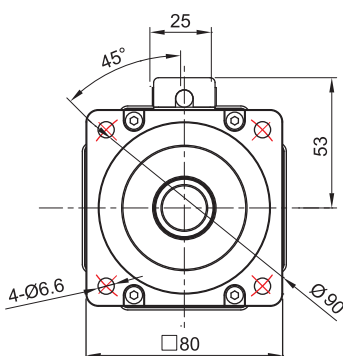

Unit : mm

Model	L
SMH-M050(B)	124(158)
SMH-M100(B)	150(184)
SMH-M150(B)	176(210)

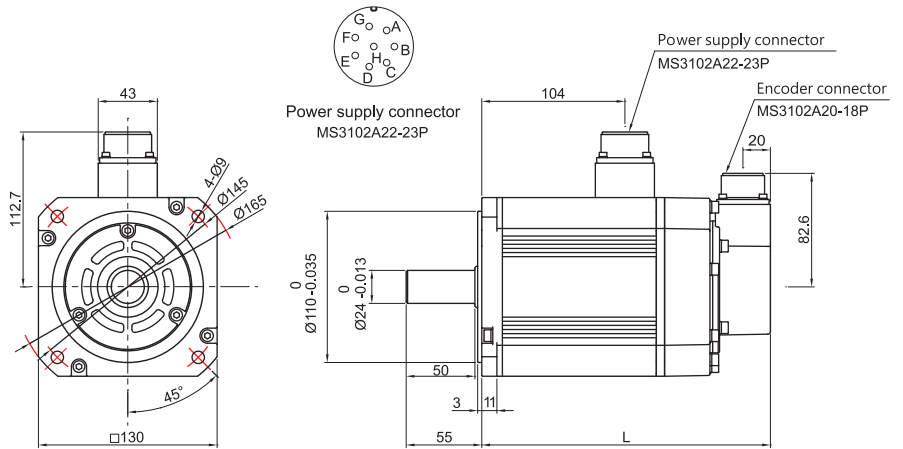

Model	L
SMH-M200(B)	149(199)
SMH-M350(B)	189(239)

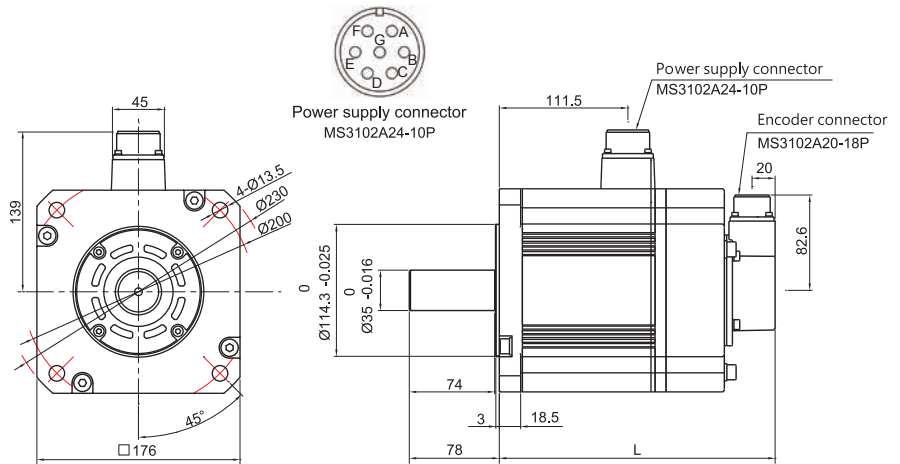

Model	LA	L
SMH-M500(B)	106.4	189(239)
SMH-M700(B)	146.4	229(279)

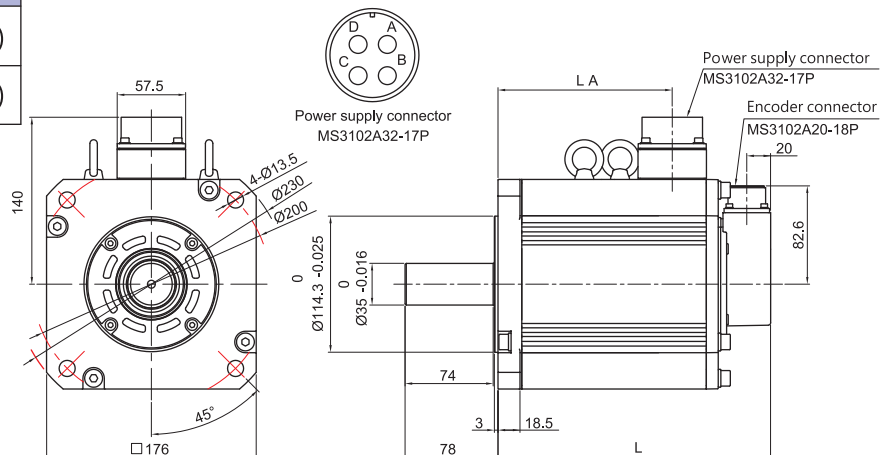

Servo Drive Dimensions

Unit : mm

SDH-010/020/040/050

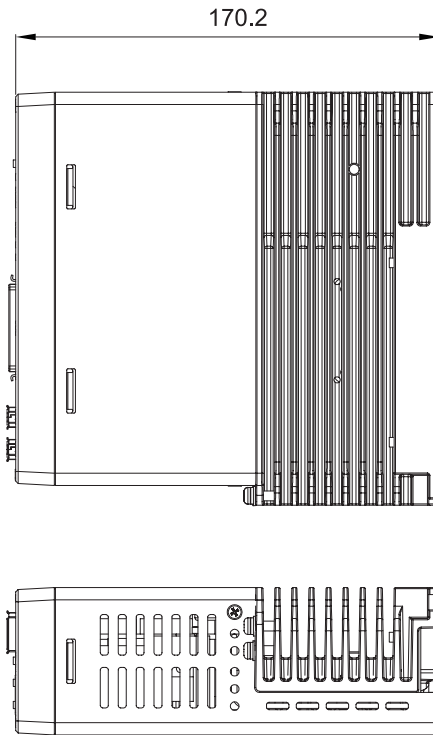
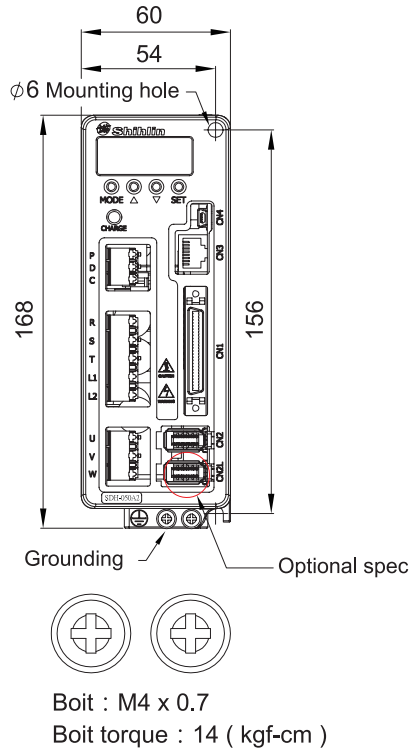

SDH-075/100

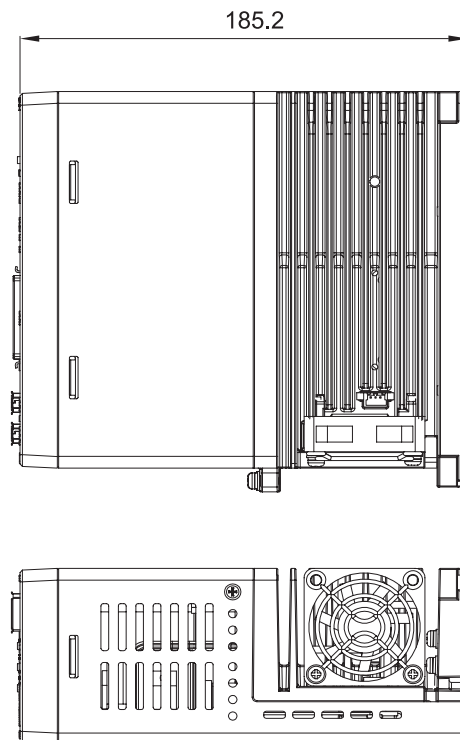
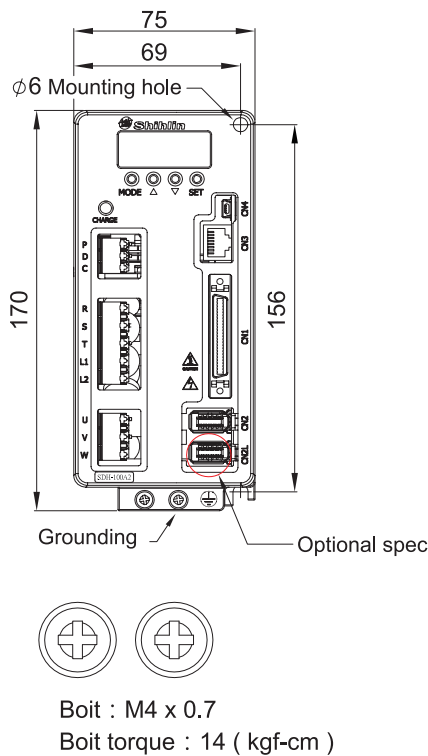

Unit : mm

SDH-150/200/350

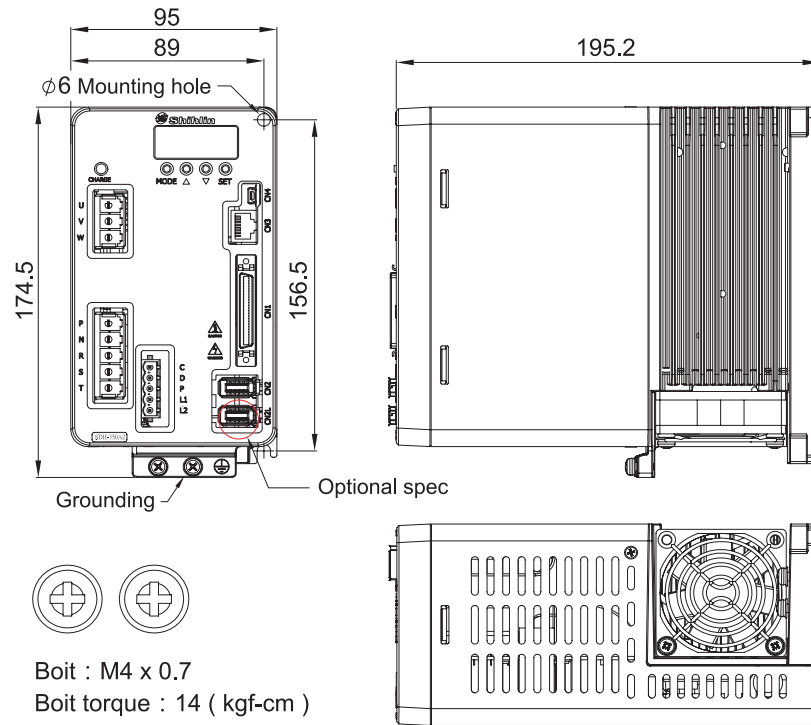

* The general type SDH servo drive has no CN2L connector.

SDH-500/700

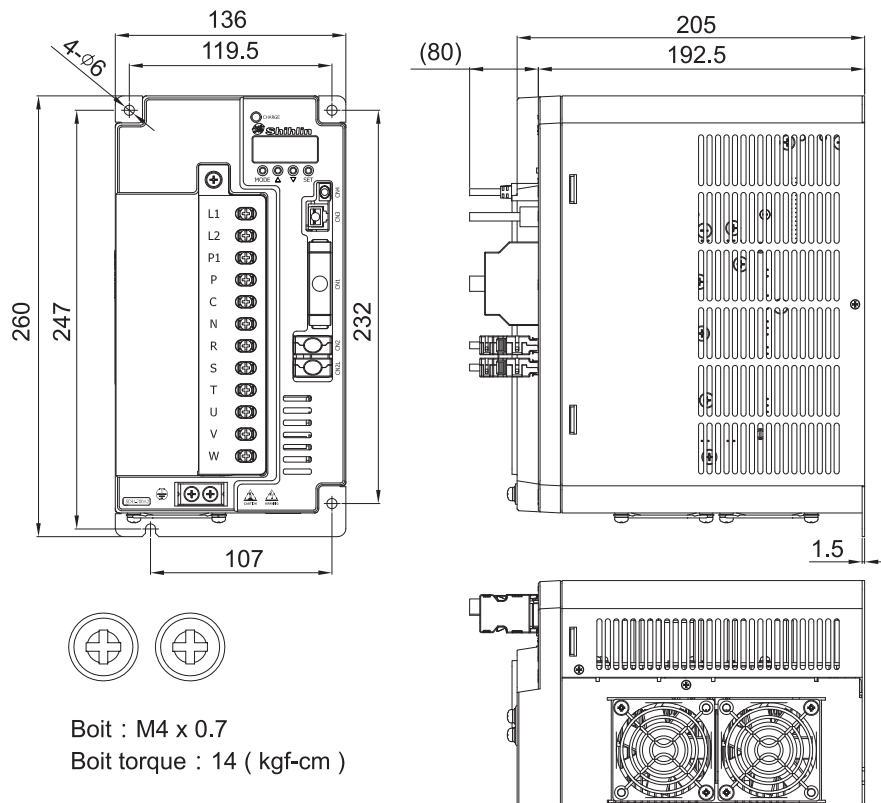

* The general type SDH servo drive has no CN2L connector.

Wiring Diagram

Pr Mode: Built-in Single-axis Control Mode Wiring Diagram

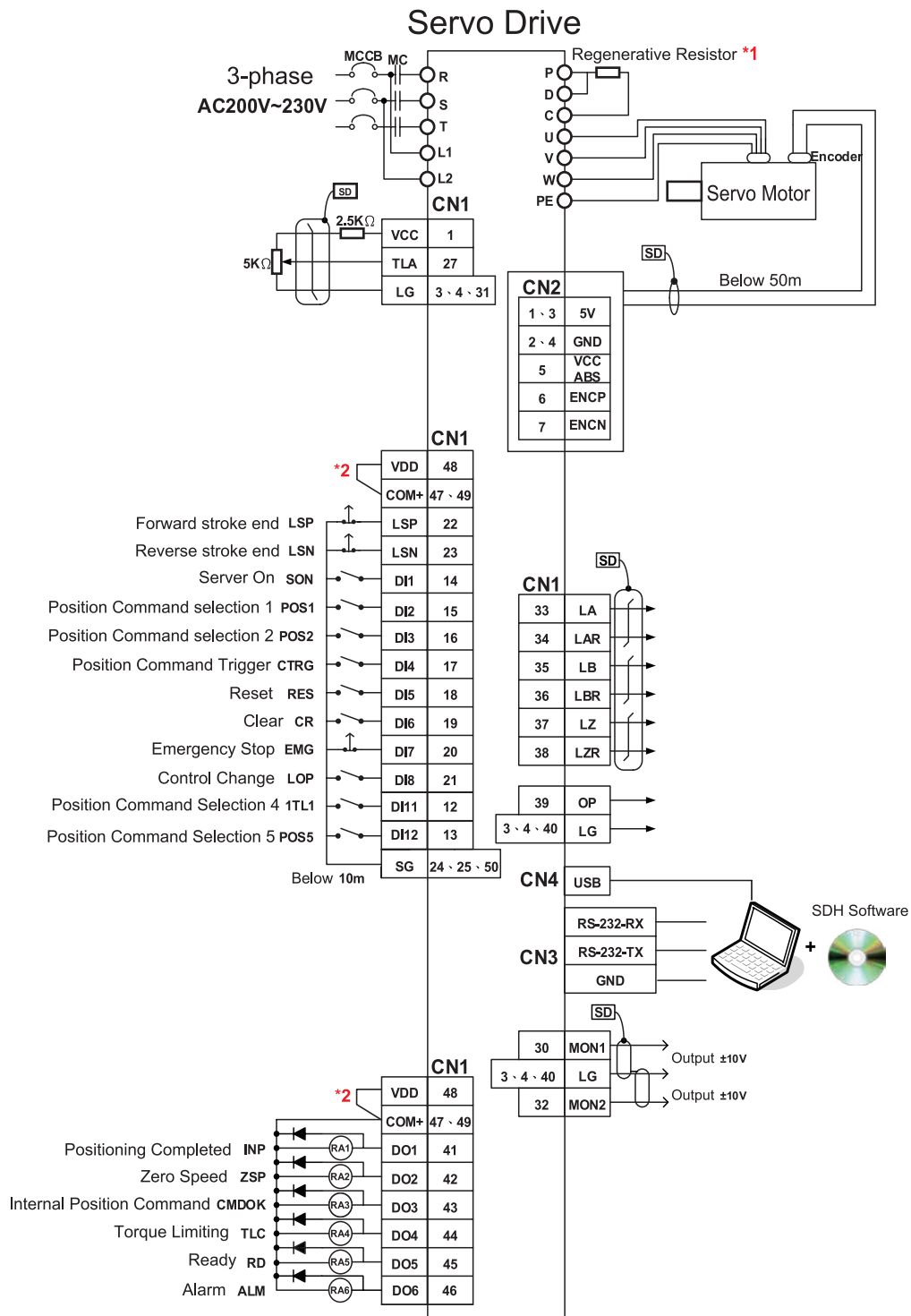

Notes

*1. Connect external regeneration unit, please remove P and D short circuit line and connect external resistor to P, C point. Every capacity has its related resistor value, please refer to "Servo Motor Specification" table in this catalog.

*2. If you use DC24V power, please don't connect VDD to COM+.

Pt Mode:Position Control Mode Wiring Diagram

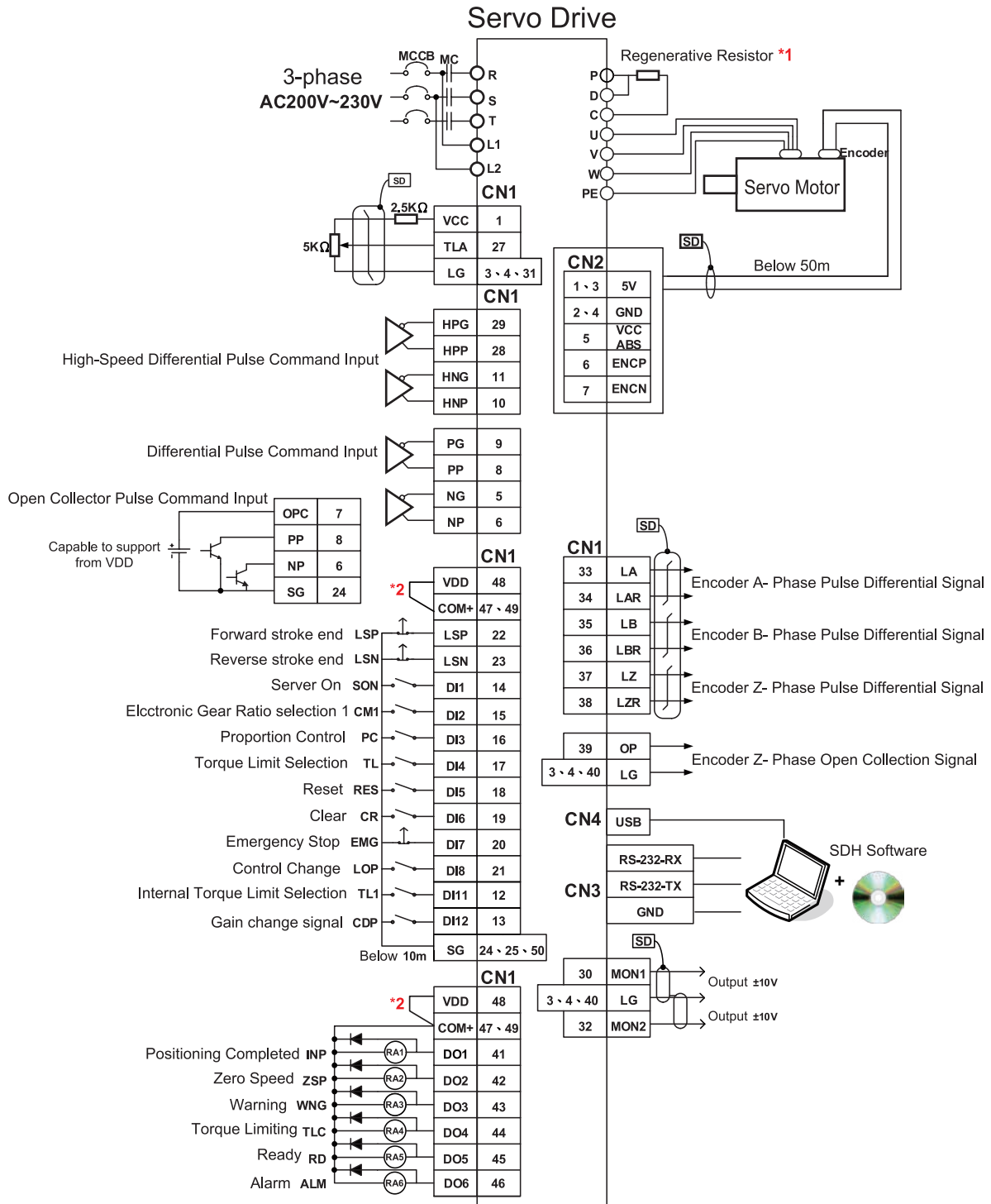

Notes

- *1.Connect external regeneration unit, please remove P and D short circuit line and connect external resistor to P, C point. Every capacity has its related resistor value, please refer to "Servo Motor Specification" table in this catalog.
- *2.If you use DC24V power, please don't connect VDD to COM+.

Wiring Diagram

S Mode:Speed Control Mode Wiring Diagram

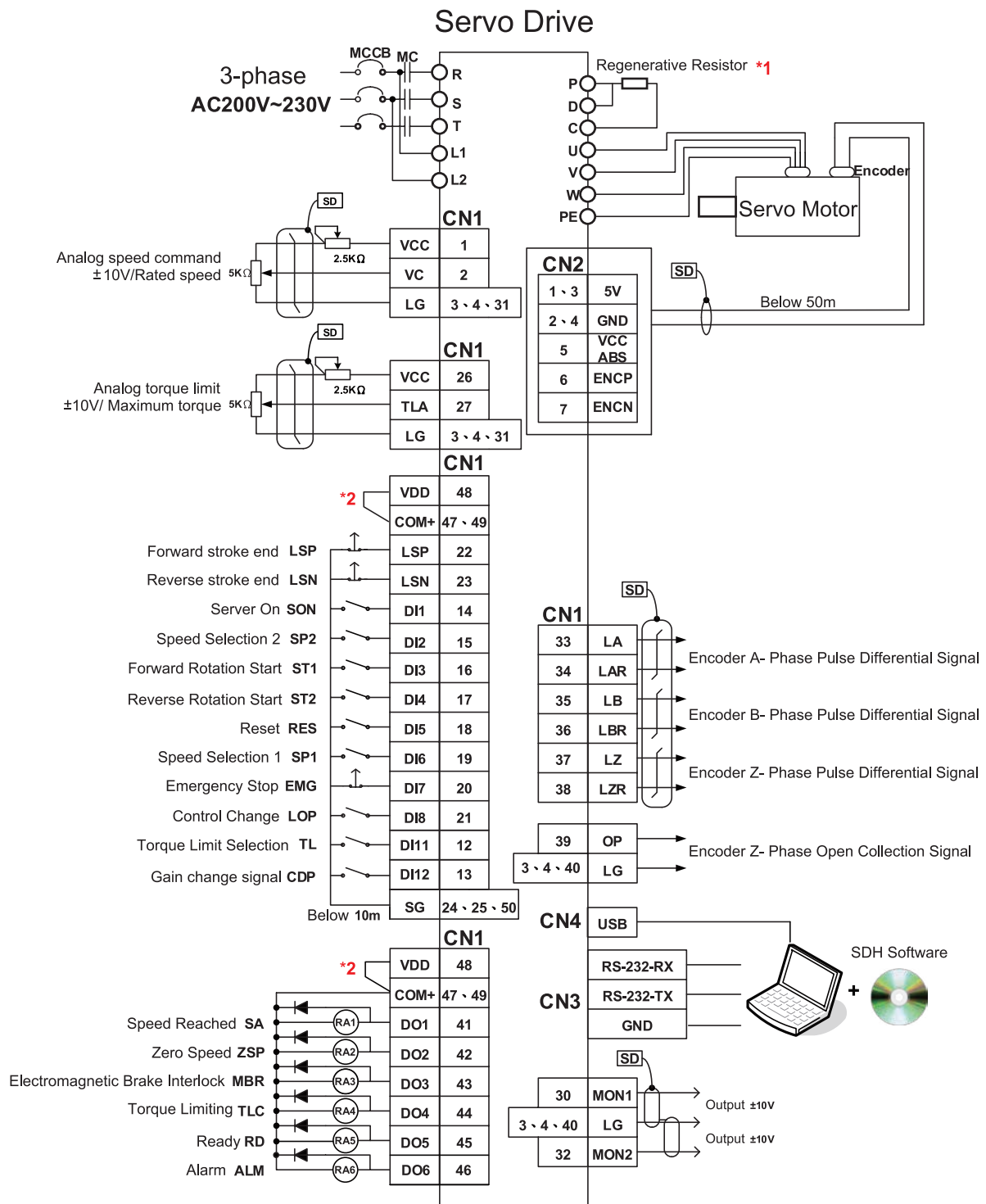

Notes

*1. Connect external regeneration unit, please remove P and D short circuit line and connect external resistor to P、C point. Every capacity has its related resistor value, please refer to "Servo Motor Specification" table in this catalog.

*2. If you use DC24V power, please don't connect VDD to COM+.



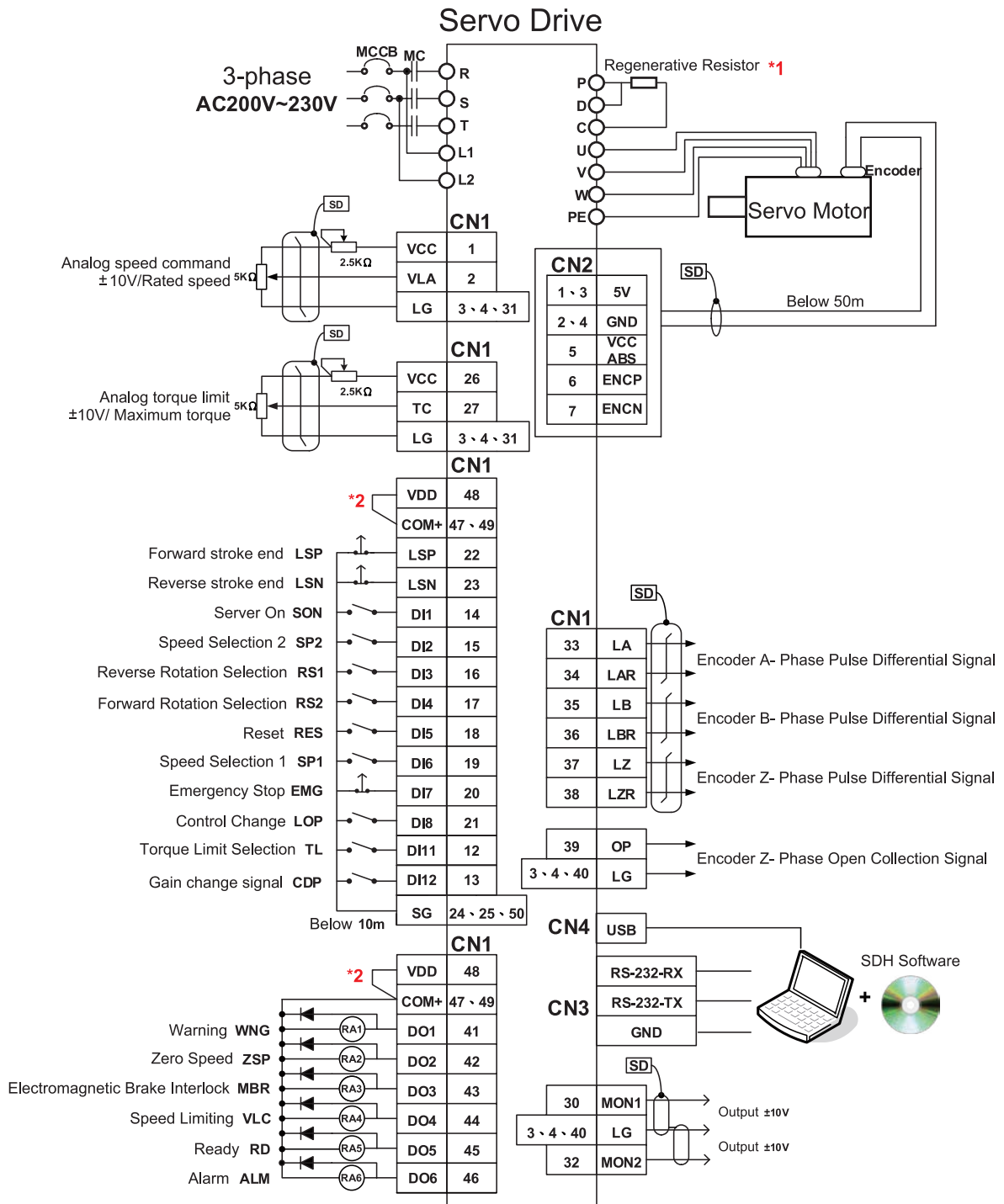







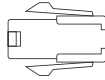
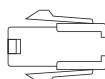
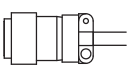

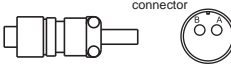
T Mode: Torque Control Mode Wiring Diagram

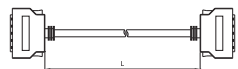
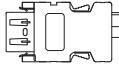

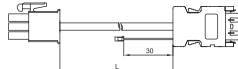
Notes

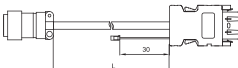
- *1. Connect external regeneration unit, please remove P and D short circuit line and connect external resistor to P, C point. Every capacity has its related resistor value, please refer to "Servo Motor Specification" table in this catalog.
- *2. If you use DC24V power, please don't connect VDD to COM+.

Optional Accessories

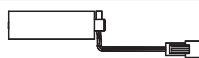
Name		Model		Content	SMH	
					L	M
Power Connector	SMH-L 100W~750W with no brake	Connector	SDA-PWCNL1		○	
		Cable	SDA-PWCNL1-□M-L/H *1*2			
	SMH-L 100W~750W with an electromagnetic brake	Connector	SDA-PWCNL2		○	
		Cable	SDA-PWCNL2-□M-L/H *1*2			
	SMH-M 500W/ 1kW/1.5kW	Connector	SDA-PWCNM1			○
		Cable	With no brake SDA-PWCNM1-□M-L/H *1*2 With an electromagnetic brake SDA-PWCNM1B-□M-L/H *1*2			
	SMH-M 2kW/3.5kW	Connector	SDA-PWCNM2			○
		Cable	With no brake SDA-PWCNM2-□M-L/H *1*2 With an electromagnetic brake SDA-PWCNM2B-□M-L/H *1*2			
	SMH-M 5kW/7kW	Power connector	SDH-PWCNM4			○
		Power cable	5kW SDH-PWCNM4-□M-L/H *1*2 7kW SDH-PWCNM5-□M-L/H *1*2			
Brake connector		SDH-BKCNS1			○	
Brake cable		SDH-BKCNS1-□M-L/H *1*2				
CN1	I/O Connector		SDA-CN1		○	○
	Terminal blocks and a wire set		SDA-TB50		○	○
			SDA-TBL05M SDA-TBL1M SDA-TBL2M		○	○
Fully closed loop control/Dual drive synchronous system			Connector	SDH-CN2		○
		Cable	SDH-CN2L-0.5M			
CN2	SMH-L	Connector	SDH-ENL		○	
		Cable	General Type SDH-ENL-□M-L/H *1*2 Absolute Type SDH-ENL-□M-L/H-B *1*2		○	
	SMH-M	Connector	SDH-ENM			○
		Cable	General Type SDH-ENM-□M-L/H *1*2 Absolute Type SDH-ENM-□M-L/H-B *1*2			○
CN3	RS232/RS485 Communication line		SDA-RJ45-3M		○	○
CN4	USB Communication line		SDA-USB3M		○	○
Battery	Absolute Encoder Battery Set		SDH-BAT-SET		○	○
	Absolute Encoder Battery		SDH-BAT		○	○

*1 □ Indicates the cable length. Standard: 2M、3M、5M、10M; Special order: other length

*2 L and H indicate bending life. L: standard, H: long bending life.

Motor Shaft Dimensions

Unit : mm

Key-way

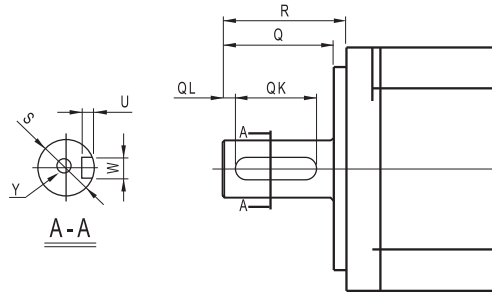

Motor models	Dimensions								
	S	R	Q	QK	QL	W		U	Y
SMH-L020(B)\L040(B)	Φ 14h6	30	26	20	3	5	0 -0.03	3	M4 Depth 15
SMH-L075(B)	Φ 19h6	40	35.5	25	5	6	0 -0.03	3.5	M5 Depth 20
SMH-M050(B)\M100(B)\M150(B)	Φ 24h6	55	50	35	5	8	0 -0.036	4	M8 Depth 20
SMH-M200(B)\M350(B)\M500(B)\M700(B)	Φ 35h6	78	74	55	5	10	0 -0.036	5	M8 Depth 20

D-cut

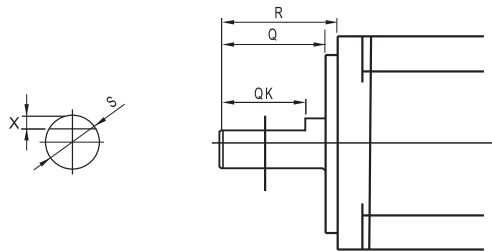

Motor models	Dimensions				
	S	X	R	Q	QK
SMH-L010(B)	Φ 8h6	1	25	21.5	20.5

Electromagnetic Brake Specifications

Motor models	SMH Series				
	L010B	L020B/L040B	L075B	M050B/M100B/150B	M200B/M350B /M500(B)/M700(B)
Electromagnetic brake types	Spring-action safety brake				
Rated voltage (V)	DC 24V 0-10 %				
Power consumption (W)	6.3	7.9	8.6	19.3	34
Static friction torque (N·m)	0.3	1.3	2.4	8.5	45



Note : The electromagnetic brake is used only for safety maintenance. Use it only when the motor is OFF. Do not use it as a motor deceleration brake.

With brake type servo motor, the exclusive power cable for must be prepared and need to input DC24V power. Please don't use drive internal VDD connector for power. Please refer to "SDH series User's Manual" for details.

**Head Office:**

16F, No. 88, Sec. 6, ChungShan N. Rd.,
Taipei, Taiwan, 111

TEL: +886-2-2834-2662

FAX: +886-2-2836-6187

HsinFun Factory (Taiwan)

No.234, ChungLun, HsinFun,
HsinChu, Taiwan, 304

TEL: +886-3-599-5111

FAX: +886-3-590-2167

SuZhou Factory (China)

No.88, Guangdong Street, Suzhou New District,
Jiangsu, China, 215129

TEL: +86-512-6843-2662

FAX: +86-512-6831-1917

Official website www.seec.com.tw
Automation Division website automation.seec.com.tw
automation@seec.com.tw